



**24th ESLS-RF Workshop
KIT, 4-6 November 2020**

**RF SYSTEMS FOR THE SOLEIL UPGRADE
RESULTS OF STUDIES FOR THE CDR
P. Marchand**



Objective :

Increase the coherent flux of photons arriving at the beam lines by ~ 2 orders of magnitude in reducing the emittance of the electron beam in the Storage Ring (SR) by a factor of ~ 50 (down to ~ 80 ps.rad or 50 ps.rad in each plane with a round beam), **while :**

- maintaining the broad spectrum of photons ranging from far IR to hard X-rays,
- reusing the existing tunnel with its radiation shielding & much of technical infrastructure,
- preserving 500 mA in multibunch as well as time structure and time resolved operations.

Highlights :

- Ring lattice : 20 non-standard alternating 7BA - 4BA High Order Achromat (HOA) cells
20 straight sections : 4 long (7.66 m & 7.35 m), 8 medium (4.15 m), 8 short (2.71 m)
20 beamlines from IDs ; super-bends (1.3 or 1.7 T) for the bending magnet beamlines
- 4-pole gradient (~ 110 T/m) ; 6-pole strength (~ 8 kT/m²) ; 8-pole strength (~ 300 kT/m³)
→ Extensive use of pure permanent magnet technology
- 10 mm diameter circular copper vacuum chamber with NEG-coating
- Synchrotron on-axis injection using a high performance Multipole Injection Kicker (MIK)

Time schedule :

- 2019 - 2020 : Studies for the CDR
- 2020 - 2022 : Studies and prototyping for the TDR
- Early 2023 : Project approval
- 2023 - 2026 : Equipment procurement
- Mid-2026 : SOLEIL shutdown → 18 months for dismantling and reinstalling
- Q4 of 2026 - Q1 of 2027 (6 months) : Commissioning
- 01/04/2028 : Beam to the users



Extremely low emittance => Very high charge density => Touschek & IBS effects



Unlike SOLEIL, the SR of the Upgrade will essentially rely on two RF systems :

- ✓ **A fundamental one at 352 MHz**, which will have to provide the required RF power and voltage for compensation of the electron beam energy loss per turn and for achieving a suitable energy acceptance.
- ✓ **A harmonic one, at 3 or 4 times 352 MHz**, aimed at lengthening the bunches up to about 100 ps FWHM (3 to 4 times their natural length) in order to preserve the low emittance and insure a suitable lifetime.
On the other hand, thanks to this harmonic system, we shall be able to produce relatively short bunches, around 10 ps FWHM, with lower beam intensity and relaxed emittance for X-ray experiments.

Even a third one might be also used, **a feed-forward system into a dedicated very wide band cavity @ 352 MHz or a harmonic**, in order to compensate the destructive effect, in terms of bunch lengthening, from the Transient Beam Loading (TBL), due the gap of empty buckets in the hybrid mode (3/4 filling).



MAIN SR PARAMETERS & FUNDAMENTAL RF SPECIFICATIONS

PARAMETERS	SOLEIL	UPGRADE
Circumference, L [m]	354	354
Energy, E _n [GeV]	2.75	2.75
RF frequency, f _{RF} [MHz]	352	352
Max beam current, I _b [mA]	500	500
Energy loss per turn, δU [keV]	1 150	770 ‡
RF power into the beam, P _b [kW]	575	385
Overall RF voltage, V _{RF} [MV]	2.8 *	1.8
Energy spread, σ _E / E	1 10 ⁻³	0.9 10 ⁻³
Momentum compaction factor, α	4.2 10 ⁻⁴	0.9 10 ⁻⁴
Emittance, ε _x / ε _z [pm.rad]	4 10 ³ / 40	81 / 0 ; 52 / 52
RF energy acceptance, (ΔE / E) _{RF}	6	7.2
Longitudinal damping time, τ _s [ms]	3.3	11.7
Transverse damping times, τ _x / τ _z [ms]	6.6 / 6.6	7.3 / 13.1
Synchrotron frequency, f _s [kHz]	4.5	1.6
Natural RMS bunch length, σ _s [ps]	16	9.2

‡ Including 280 keV for the ID's

* 2.8 MV in standard operation, 3.2 MV in low α mode (α_{nom} / 25)



PRESENT SOLEIL SR RF SYSTEM

- $E_n = 2.75 \text{ GeV}$, $\Delta E = 1.15 \text{ MeV}$, $I_b = 500 \text{ mA}$
→ $P_{RF} = 575 \text{ kW}$ and $V_{RF} \approx 3 \text{ MV @ } 352 \text{ MHz}$
- 2 Cryomodules (CM's), each containing a pair of HOM damped SC cavities (Nb/Cu)
- Each of the 4 cavities is powered with a 200 kW solid state amplifier (SSA)
- Both CM's are supplied with LHe (4.2 K) from a single cryogenic plant

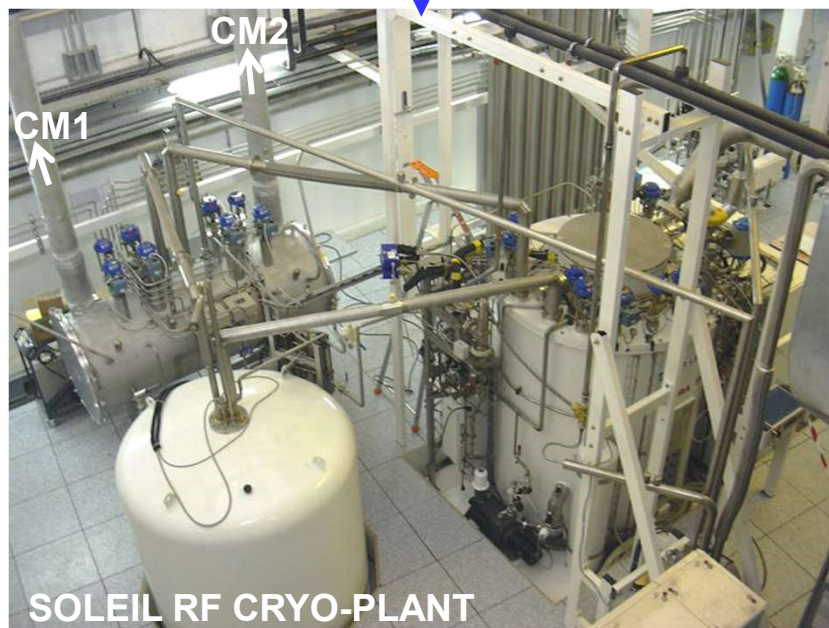
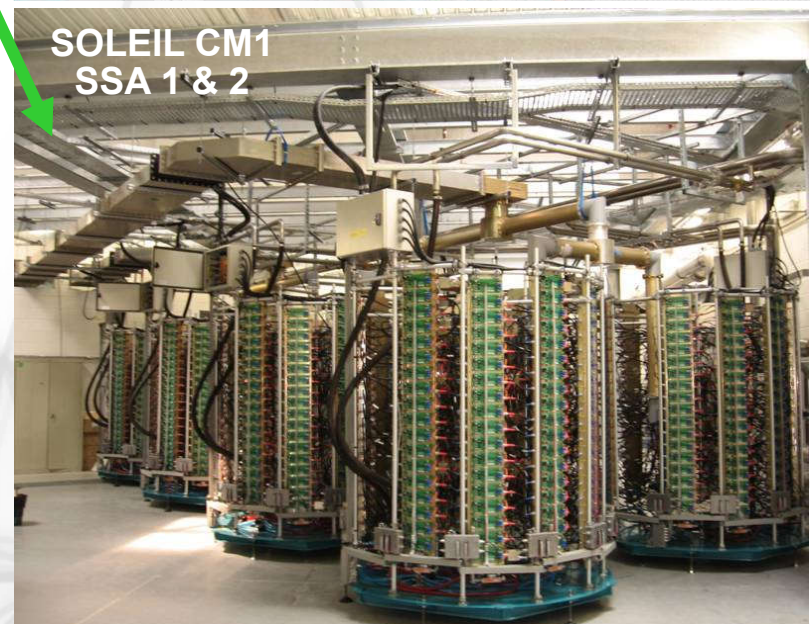

OPTION 1 (SC)

Reuse 1 of the 2 cryomodules presently operating in SOLEIL with its 2 SC cavities

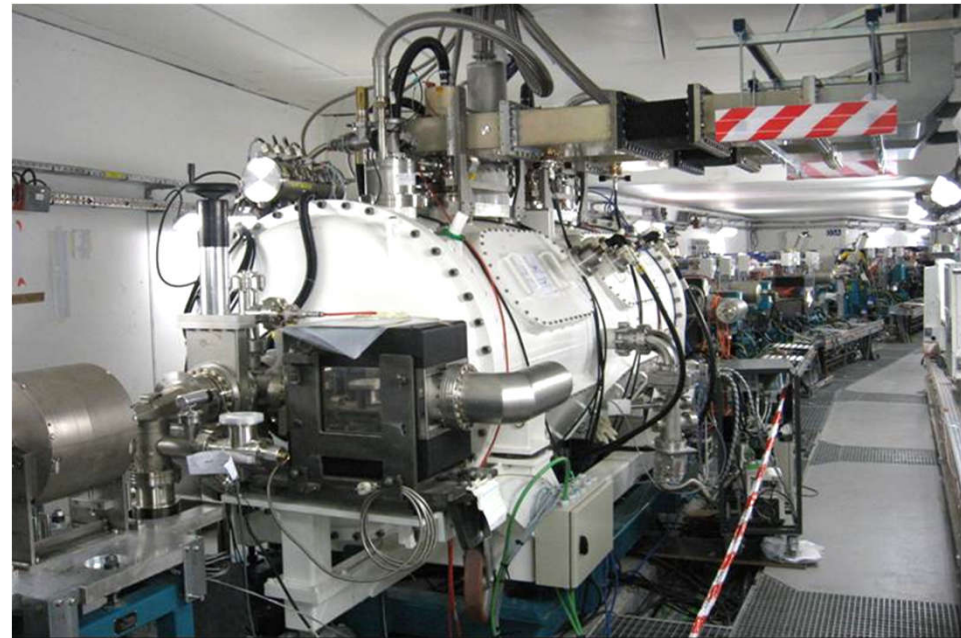

OPTION 2 (NC)

Use 4 ESRF-EBS NC cavities

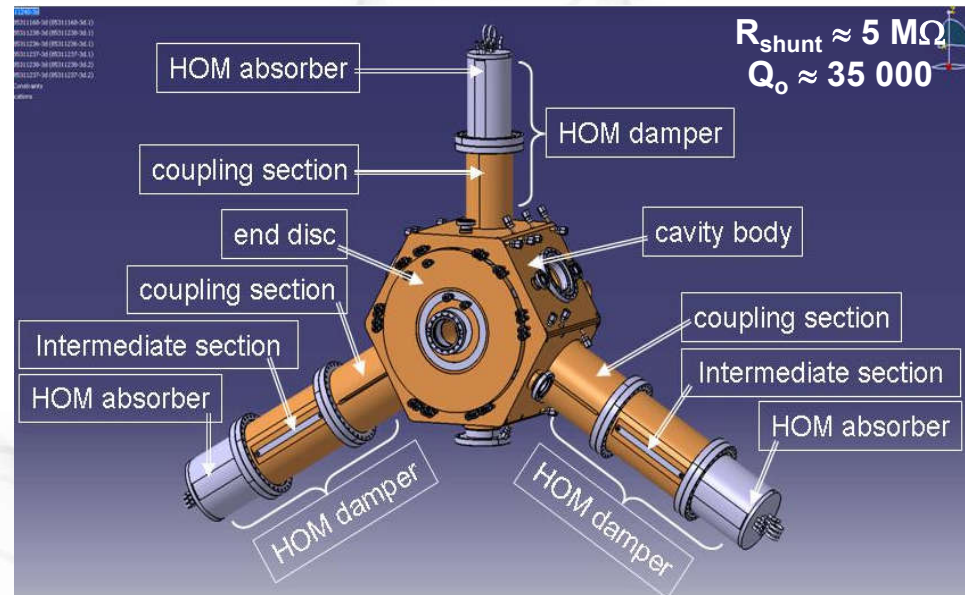
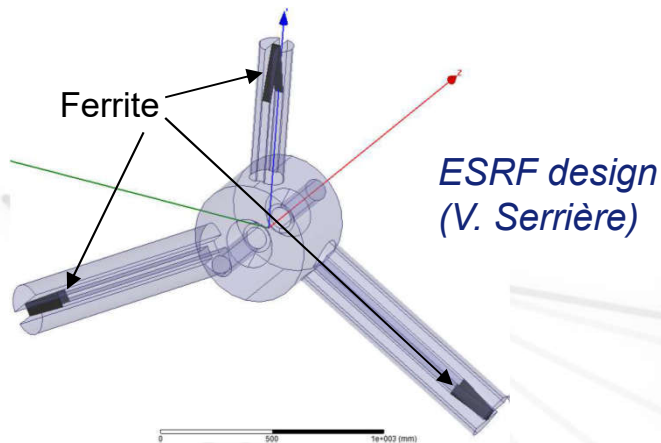

CHOICE OF THE 352 MHZ CAVITIES

NC version more favorable on most aspects

	1 SOLEIL CM 2 SC cavities	4 (3) NC cavities ESRF-EBS
Length [m]	~ 6	< 4.15
Redundancy	No	Yes
V_{RF} [MV]	1.8	1.8
P_b [kW]	385	385
V_{cav} [kV]	900	450 (600)
P_{dis} [kW]	≈ 0	4 x 20 (3 x 36)
P_{cav} [kW]	193	117 (165)
P_{RF} [kW]	385	470 (495)
Coupling	$Q_{ext} = 5 \cdot 10^4$	$\beta_c = 5$
Z_{HOM}	Ok	TBD

Required space: 4 NC cavities fit in a 4.15 m medium straight section

Redundancy: the SC system with a single CM and cryo-plant does not provide any redundancy while the nominal performance is still achievable with 3 out of 4 NC cavities in use (**+ 5% power**)

Operational cost: the NC system requires some more RF power (P_{RF}), due to the cavity wall dissipation (P_{dis}); however, taking into account the electrical power consumption of the cryo-plant (~ 300 kW), it remains less power-consuming & no need for cryogenic coolant (He & N₂)

Investment cost: using NC fundamental cavities makes the existing cryo-plant available for the harmonic system (next slides) and the cost of 4 NC cavities (~ 2 M€) << the cost of a cryo-plant

All the above reasons, led us to favor the NC option with 4 cavities of the ESRF-EBS type, each being powered with its own amplifier; **however, remains to demonstrate that it is relevant in terms of HOM impedances.** Although up to 200 mA have been already stored in the ESRF SR using 13 such cavities without any occurrence of coupled bunch instability (CBI), this is not yet conclusive for the SOLEIL Upgrade case, which is more critical in this respect.

The cavity HOM's can drive CBI's when their impedances exceed a certain threshold :

$$\left. \begin{aligned} (R_{hom} * f_{hom})_L &\approx (2 * f_s * E/e) / (I_b * \alpha * f_{rev} * \tau_s) , \text{ in the longitudinal plane} \\ (R_{hom})_{x,z} &\approx (2 * E/e) / (I_b * \beta_{x,z} * f_{rev} * \tau_{x,z}) , \text{ in the transverse planes} \end{aligned} \right\} \begin{array}{l} \text{Worst case} \\ \text{at resonance} \end{array}$$

Computations of the HOM impedances, made by ESRF, using the codes HFSS (frequency domain) and GdfidL (time domain), show that most of their cavity HOM's are well below the SOLEIL Upgrade CBI thresholds (as defined above), except for two of them :

- A longitudinal one at $f_{hom} \approx 1.7$ GHz, which is found slightly above ($\sim 35\%$)
- A transverse one at $f_{hom} \approx 0.8$ GHz, which can be either below or slightly above, depending on the fundamental frequency tuning
- Removing the vertical damper does not significantly affect these results *

** At ESRF, the vertical damper termination has finally not been mounted (sufficient damping without it & the risk that ferrite pieces fall down into the cavity is eliminated)*

- ✓ These preliminary computations have to be completed and refined (evaluate the Landau damping from the harmonic system, model the cavity tapers and main coupler, ...)
- ✓ The bunch by bunch transverse feedback presently operating in SOLEIL will be reused anyway on other grounds (resistive wall, TMCI, ions, ...) → Transverse HOM damping
- ✓ Besides, ESRF has agreed with the loan of its 2 spare cavities to test them in SOLEIL SR
 - Hands-on experience and knowledge
 - Conclusive for the actual SOLEIL Upgrade case ? → Under investigations

HIGH ORDER MODES (HOM'S) OF THE ESRF-EBS CAVITIES

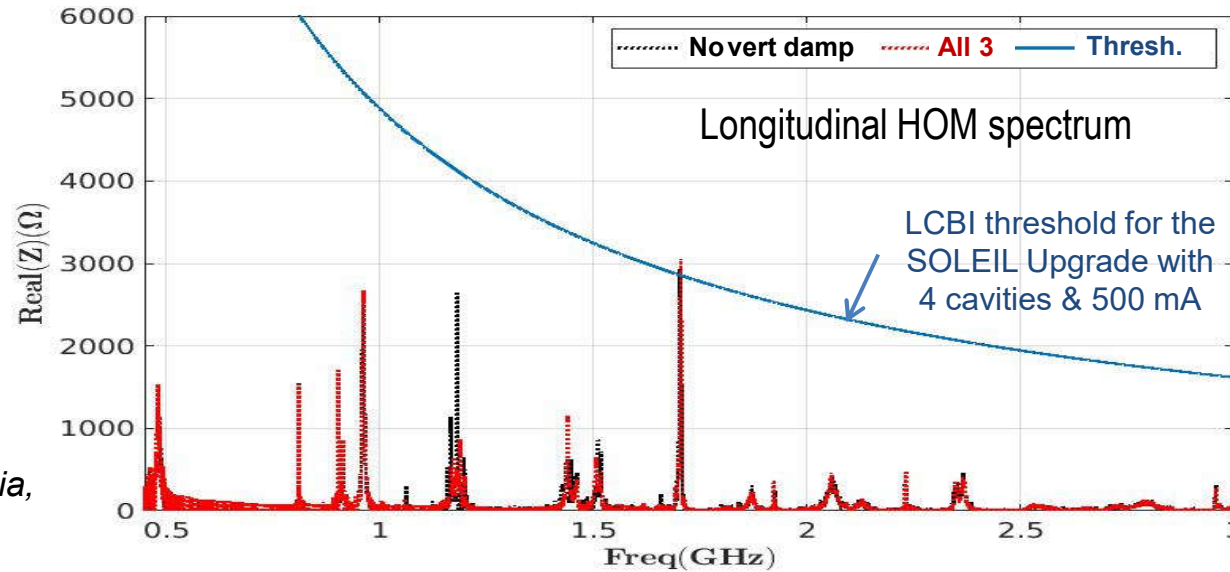

Alessandro D'Elia,
ESRF

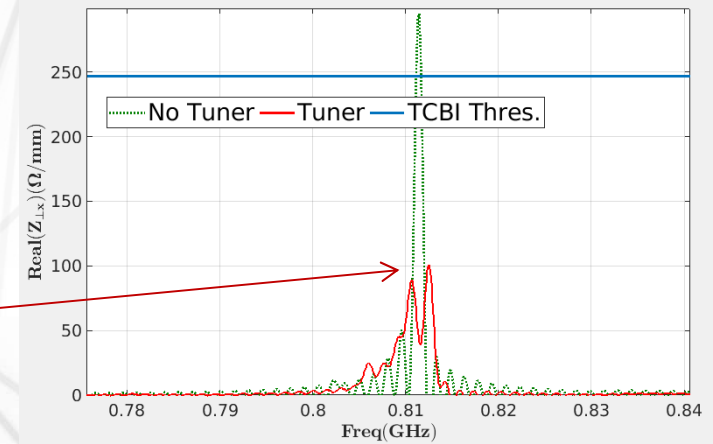
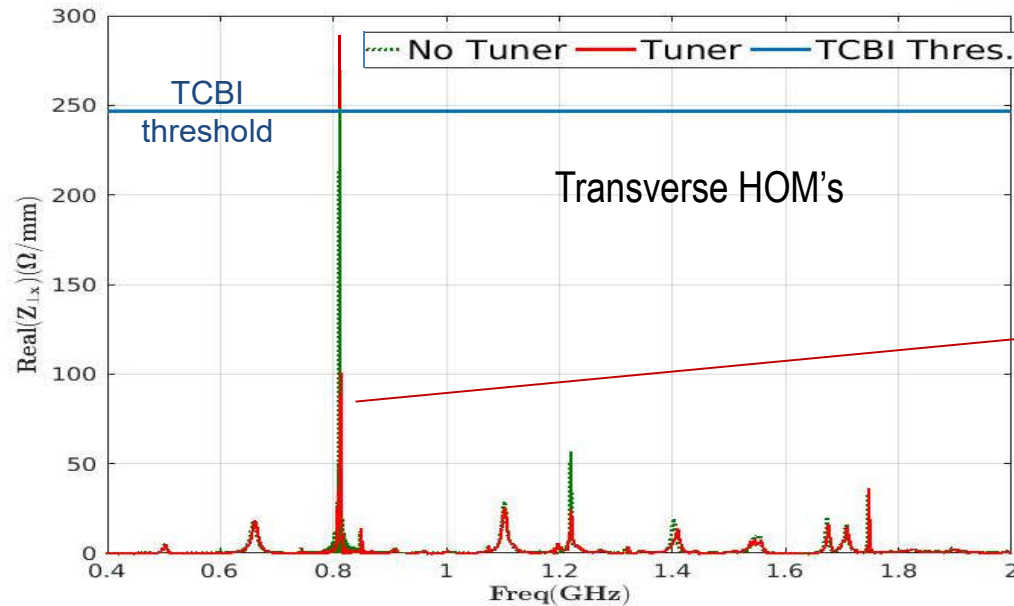

XXXXXXXX

352 MHZ POWER SOURCES

In the SOLEIL SR, four 200 kW SSA's in use (one per cavity), each consisting in four 50 kW towers.

- Developed in house, they are based on combinations of elementary SSA modules of ~ 300 W (165 / tower, ~ 3000 total), each having its own LDMOS transistor, circulator and 270/50 V dc-dc converter power supply.
- 20 years ago, the choice of this technology was quite a challenge; however, after 15 years of operation they have shown an outstanding level of reliability, thanks to **their extreme modularity / redundancy and the absence of HV \rightarrow Very low phase noise**
- Our SSA's were still upgraded recently in replacing the original transistors by new generation ones, more robust and more performant in terms of power, gain and efficiency.
- The way of replacing their power supplies for the use of ac-dc converters, connected directly on the mains - as we have already made in recent projects (SESAME, THOMX) - is being investigated; that will solve obsolescence issues and still improve their adaptability, efficiency and reliability.



\rightarrow Reuse these four SSA's in the SOLEIL Upgrade SR, after other possible adaptations, as for instance connecting each tower directly on the waveguide \rightarrow Gain in flexibility. They will remain at their present location and the waveguide network will be adapted to reach the new cavity locations, in the SDM02 section of the SR.

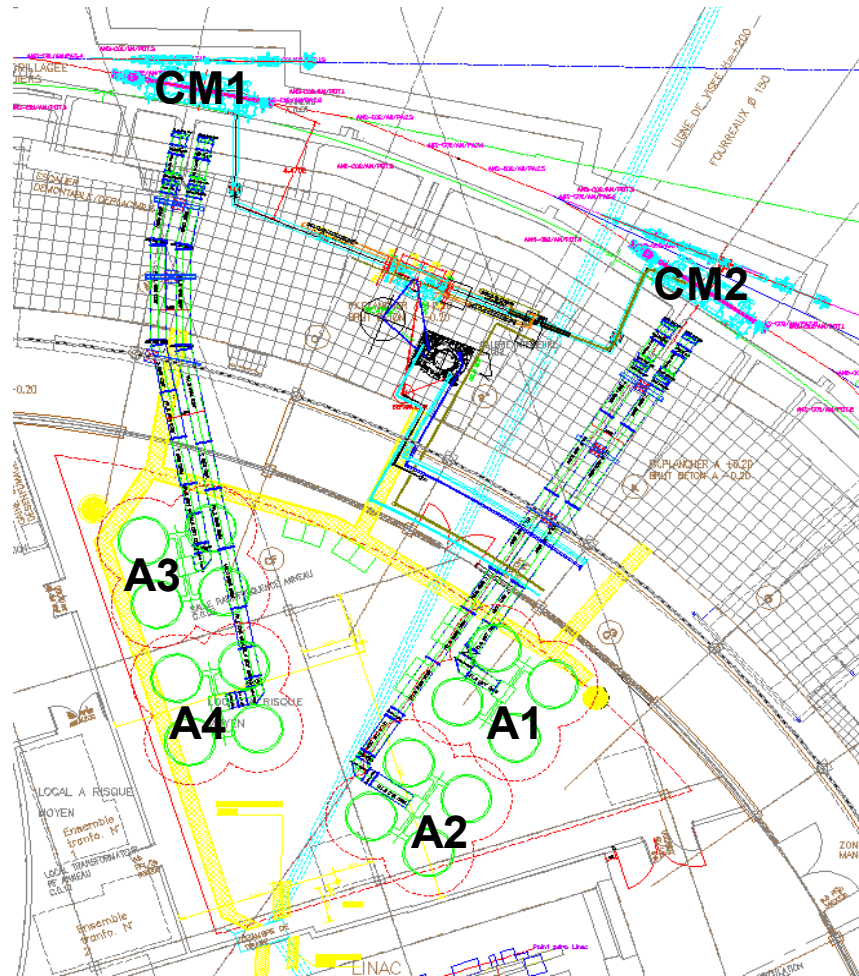

**Present SOLEIL RF layout
4 SSPA's & 2 cryomodules**

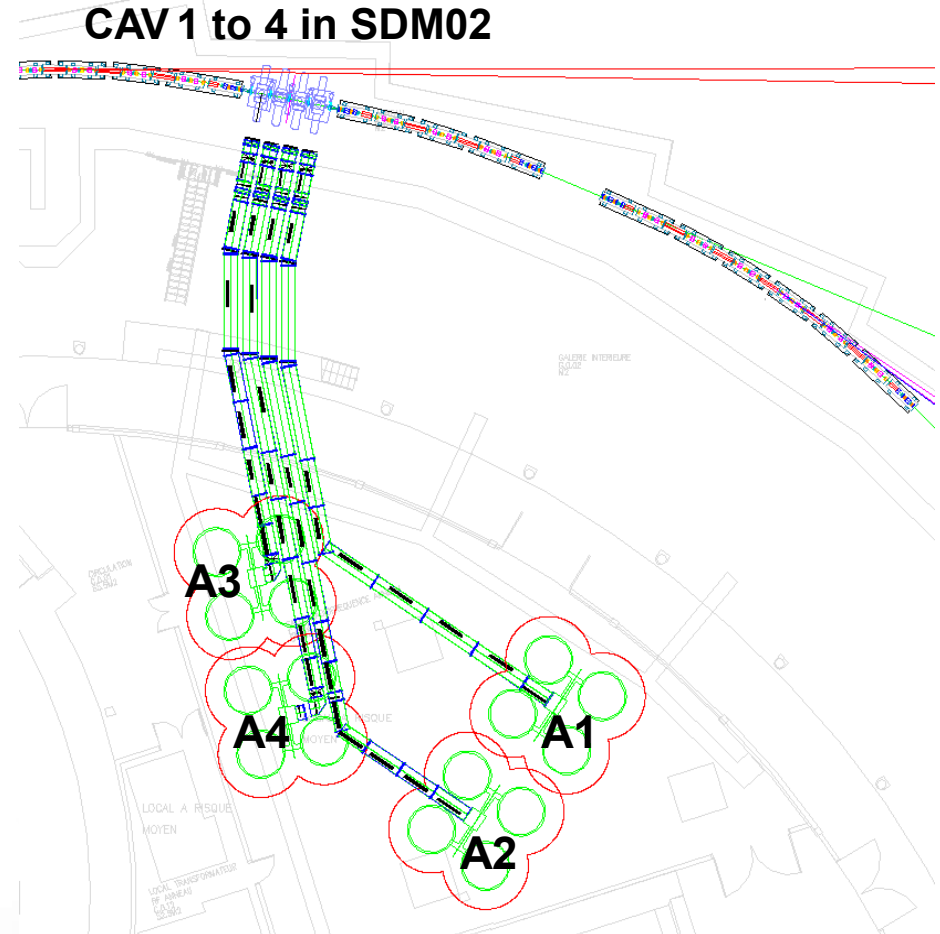

**SOLEIL Upgrade RF layout
4 SSPA's & 4 NC cavities**

352 MHz LLRF SYSTEMS

- ✓ In the present SOLEIL LLRF systems, the frequency, amplitude and phase regulation loops as well as the direct RF feedback are fully analogic.
- ✓ A generic digital LLRF, based on a μ TCA / Zynq environment, is being developed for our LUCRECE project at 1.3 GHz, which will be easily adapted for the SOLEIL Upgrade.

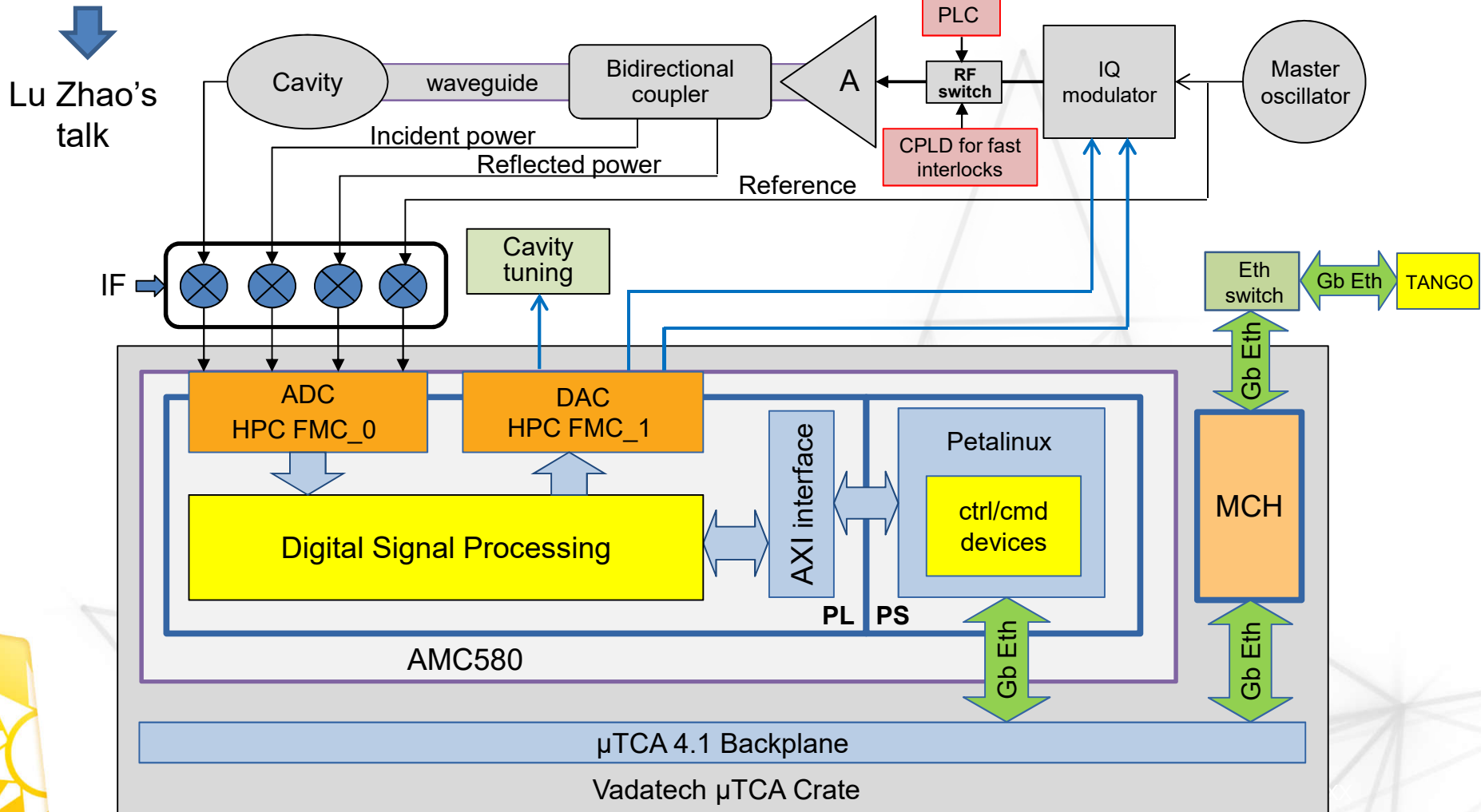

In the SOLEIL Upgrade SR, the harmonic RF system will have to fulfill two tasks :

1. Lengthen the bunches up to ~ 100 ps FWHM and thus reduce their charge density so as to preserve the low emittance and insure suitable beam lifetime
2. Provide relatively short bunches, ~ 10 ps FWHM, with lower current and relaxed emittance

SOLEIL Upgrade 3rd harmonic case

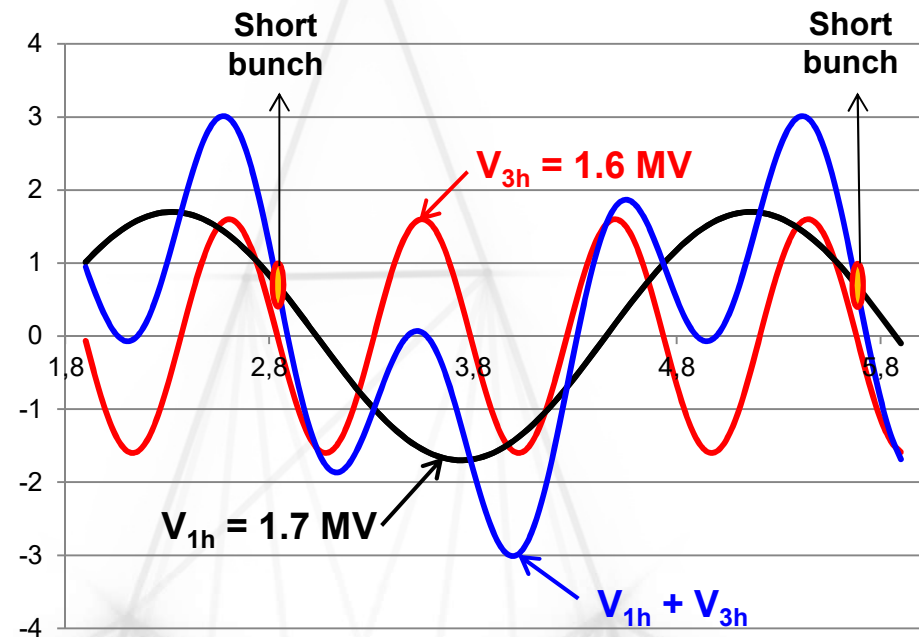
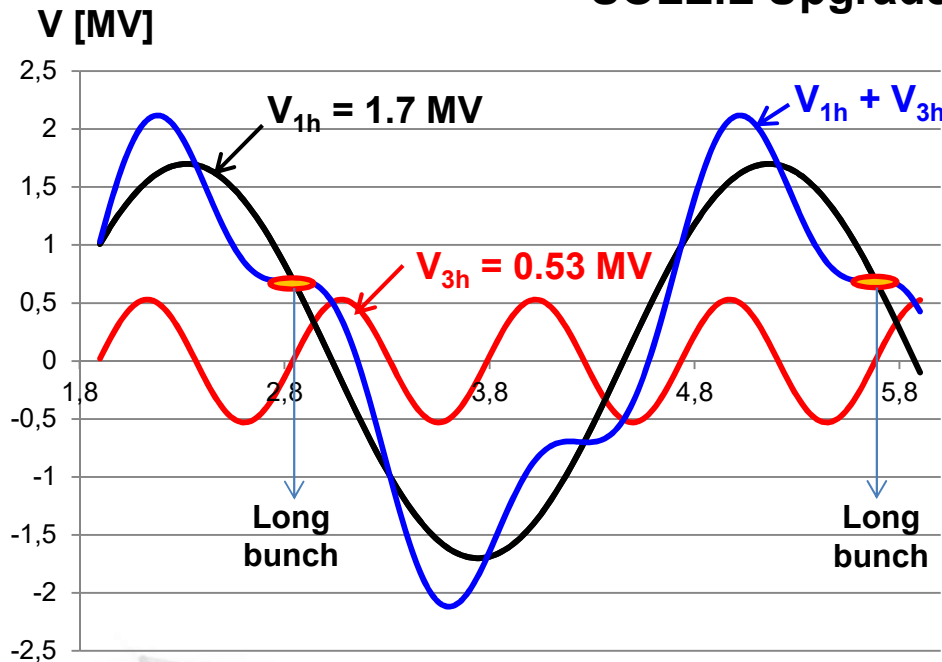

1. Bunch lengthening : phase and amplitude of V_{3h} adjusted such that the overall voltage is flat at φ_s
For $V_{3h} \approx V_{1h} / 3 \approx 0.53$ MV, $\tau \approx 4 \tau_o \approx 100$ ps FWHM

2. Bunch shortening : V_{3h} set at opposite phase so as to increase the overall voltage slope at φ_s
For $V_{3h} \approx 1.6$ MV, $\tau \approx \tau_o / 2.5 \approx 10$ ps FWHM

HARMONIC RF SYSTEM TECHNOLOGICAL OPTIONS

- ✓ The required performance could be achieved using several technological options : **NC or SC, passive or powered, 3rd or 4th harmonic RF systems**, which are all under investigation and compared in terms of stability, TBL, compatibility with all modes of operation, etc.
- ✓ This study is conducted in the frame of a collaboration with ESRF, KEK, PSI and HZB, which encounter similar problematics ; longitudinal beam dynamics simulations are performed using two particle tracking codes, Mtrack and P-Elegant, whose results will be crosschecked with the experimental ones from tests in SLS (SC cavities) and BESSY II (NC cavities).
- ✓ Although all options remain open, **a passive SC RF system of the Super3hc type**, scaled to 3 or 4 times 352 MHz (1.06 or 1.41 GHz), is considered as the most suitable for the SOLEIL Upgrade. **The Super3hc CM**, used in SLS and ELETTRA, is already a scaling to 1.5 GHz of the SOLEIL CM with two HOM free SC cavities, but they are **passive**, without any input power coupler.

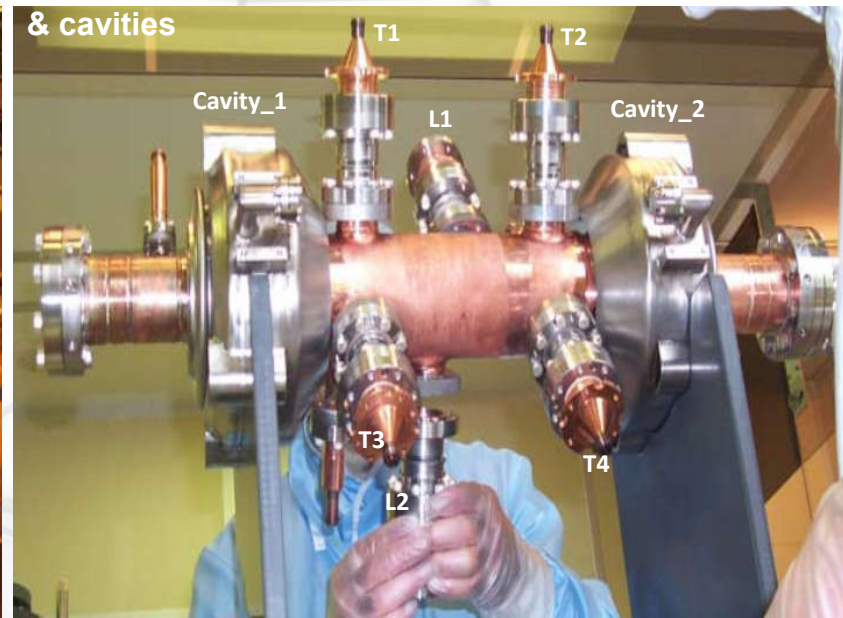
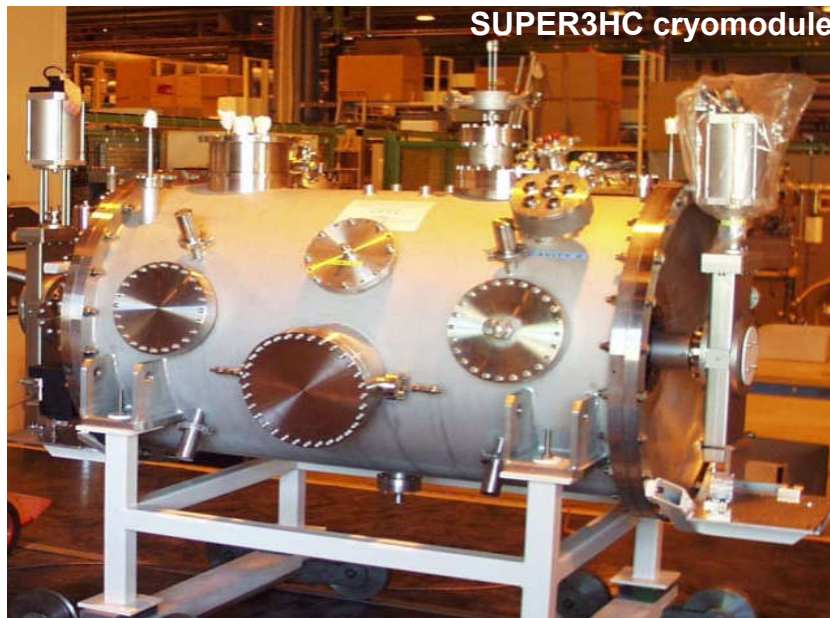

PASSIVE SC CAVITY CASE

- ✓ The great advantage of using passive SC cavities is that **one can take full profit of the beam induced voltage**, which requires neither external harmonic power source nor additional power from the fundamental RF system.
- ✓ The cavities are not anymore seen by the beam as resonators but as ***pure (lossless) reactances***, which makes their operation much easier, without need for phase control and fast feedbacks in order to insure the stability (Robinson, μphonics, ...), as required for the powered ones.
- ✓ At given current I_b , the induced voltage is simply inversely proportional to δf , the cavity detuning: $V_{ind} \approx I_b * R/Q * f / \delta f$, **as far as $\delta f \gg f/Q$** and for SC cavities with very narrow bandwidth, this condition is met even at beam current as low as a few mA.
- ✓ A marginal drawback of such a passive system, controlled only by its tuning, is that it produces a slight asymmetry in the bunch shape.
- ✓ A limitation could come from the AC Robinson instability at low I_b in single bunch mode (~ 20 mA), when the cavities have to be tuned close to synchrotron sidebands; however, first Mtrack computations show **stable conditions even at I_b as low as 10 mA**.
- ✓ Moreover, **using SC cavities allows minimizing the TBL in non-uniform filling**, although it remains quite critical (next slide).

One of the SOLEIL operating modes is the « hybrid mode » with $\frac{3}{4}$ of the SR uniformly filled and only a single bunch in the last quarter (312 x 1.42 mA + 1 x 5 mA).

In the SOLEIL Upgrade, the TBL resulting from such long gaps of empty buckets will generate phase shifts along the bunch train, which will strongly affect the bunch lengthening efficiency from the harmonic system and could be also an issue for the injection.

- Uniform filling (no TBL)
 - $V_{3h} = 0 \rightarrow \sigma = \sigma_o$ (natural) ≈ 9.5 ps rms
 - $V_{3h} \approx V_{fund}/3 \rightarrow \sigma \approx \sigma_{max} \approx 50$ ps rms
 - $\Delta\Phi_s = 0$ (same phase for all bunches)

- TBL in hybrid mode, 450 mA in $\frac{3}{4}$ filling (312 x 1.44 mA & 104 empty buckets) and $V_{3h} \approx V_{fund}/3$

→ $\Delta\Phi_s / \omega_{RF} : \pm 210$ ps

→ σ : from σ_{max} down to σ_o

*Results from Mtrack computations
(N. Yamamoto, KEK)*

$\Delta\Phi_s / \omega_{RF} \approx 0.5 * \text{R/Q} * I_b * T_{gap} / V_{RF}$

R/Q is ~ 10 times lower with SC cavities

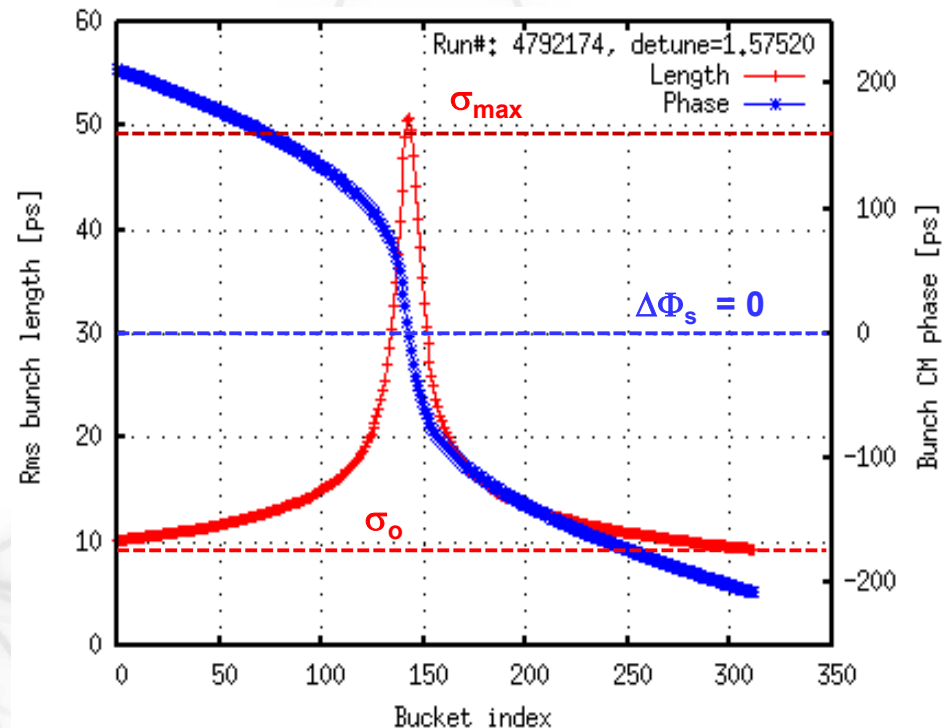

POSSIBLE TRANSIENT BEAM LOADING (TBL) COMPENSATION

We are studying the possibility of compensating the TBL destructive effect with a **feedforward into a dedicated very wide band kicker cavity** ($BW > f_{rev}$), at 352 MHz or harmonic, as proposed by KEK.

352 MHz kicker cavity :

$R_s = 5 \text{ M}\Omega$; $Q_o = 35\ 000$

$\beta_c = 350 \rightarrow BW = 3.5 \text{ MHz}$

$P_{peak} = 115 \text{ kW}$; $\langle P \rangle = 57 \text{ kW}$

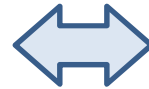

Results from Mtrack computations
(Naoto Yamamoto, KEK)

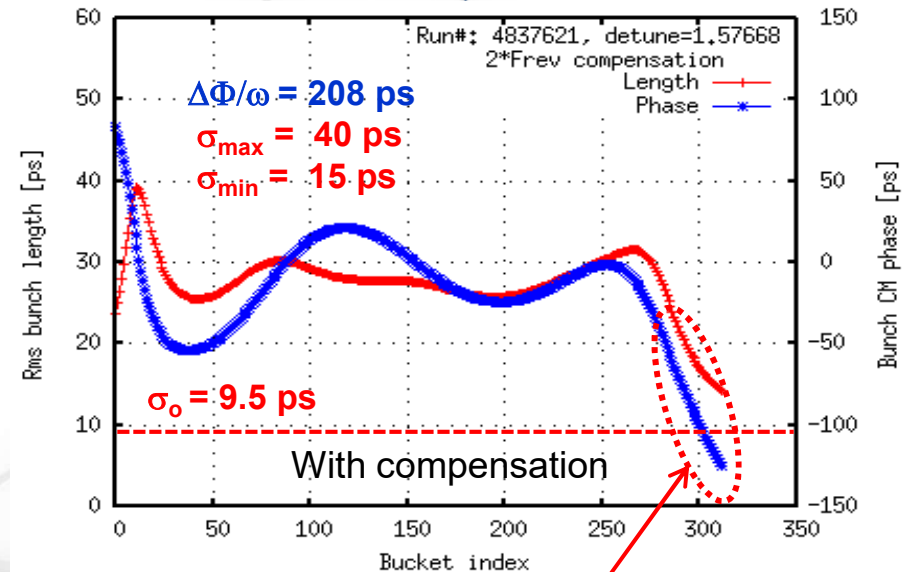
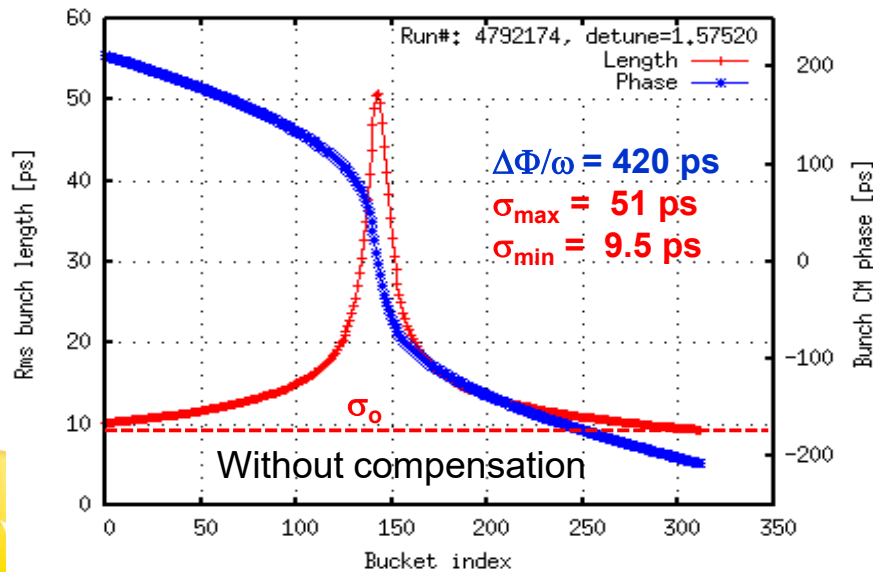
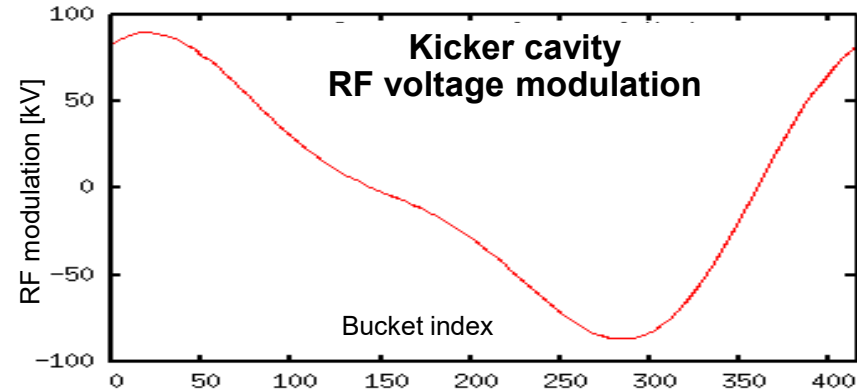

The feedforward compensation brings a significant benefit **but it remains insufficient**. Similar results can be obtained with a harmonic kicker cavity ; investigations are going on.



COLLABORATION PROJECTS

- ✓ In 2018, the RF Groups of SOLEIL and ESRF, which had common problematics within the frame work of their upgrades, proposed to collaborate on 4 WP's, as listed below ; then in a second stage, 3 other labs, KEK, PSI, HZB decided to join some of these WP's.

	SUBJECTS	PARTICIPANTS
WP1	Test of a pair of 352 MHz ESRF-EBS type cavities in the SOLEIL SR, in passive mode for their qualification in terms of HOMs	ESRF/SOLEIL
WP2	Beam dynamic studies in presence of harmonic RF systems (tracking code computations & experiments on existing machines)	SOLEIL/ESRF/KEK PSI/HZB
WP3	Design and implementation of a harmonic RF system with TBL compensation	ESRF/SOLEIL/KEK
WP4	Design of a μ TCA based DLLRF system adaptable to all the above RF systems (fundamental, harmonic and TBL compensation)	SOLEIL/ESRF/HZB

- ✓ The formal agreements (one for each of the above WP's) are under writing
- ✓ Two other tripartite collaborations are being set up :
 - Design & realization of a Super3hc type CM @ 1.41 (or 1.06) GHz → SOLEIL/CEA/CERN
 - Development of a 40 kW SSA @ 1.41 GHz → SOLEIL/SigmaPhi-Electronics/ESRF



For the SR of the SOLEIL Upgrade fundamental RF system at 352 MHz, it is proposed to use **four NC cavities of the ESRF-EBS type, each powered by one of the SSA's presently operating in SOLEIL.**

Remains to demonstrate that all the cavity HOM's are sufficiently damped without need for any additional longitudinal feedback system ; as for the transverse planes, the bunch/bunch transverse feedback presently operating in SOLEIL will be reused.

Although other options are still open and studied, **the use of a Super3hc type CM with two passive SC cavities, adapted to 3 or 4 times 352 MHz,** is regarded as the most suitable solution to achieve the required bunch lengthening and shortening.

The main issue may come from the destructive effect on the bunch lengthening, produced by the **Transient Beam Loading in the hybrid mode with 3/4 filling.** The phase dispersion, induced along the bunch train, could also be an issue for the injection.

The possibility of compensating this effect by means of **a feedforward system into a dedicated very wide band 352 MHz or harmonic cavity** is under investigations.

A generic digital LLRF system, based on μ TCA, which can be adapted to all these RF systems (fundamental, harmonic, TBL compensation), is being developed.

Collaboration projects, aimed at conducting R&D's in the above domains are being set up with other labs (ESRF, HZB, KEK, PSI, CEA, CERN) & SigmaPhi Electronics.

Many thanks to :

- Naoto Yamamoto (KEK) for having contributed with Ryutaro Nagaoka and Alexis Gamelin (SOLEIL) to the evolution of our particle tracking code, Mbtrack and performed much beam dynamics computing
- The ESRF RF team for having communicated much information about their cavities
- Lukas Stingelin (PSI), who has started to manage first tests with Super3hc in the SLS
- All members of SOLEIL, involved in the SOLEIL Upgrade project, in particular from the Accelerator Physics group as well as my colleagues of the RF and Linac group

And wishes of success to the collaboration projects, which are being set up with ESRF, KEK, PSI, HZB, CEA, CERN and Sigmaphi-Electronics.

Thank you for your attention

